

TANKLIGHT 140



Round, recessed IP65 downlight. Top quality COB LED module with colour consistency MacAdams 3, extensive portfolio of lumen ranges, CCTs and spectra. Variety of drivers: standard EVG on/off, DALI and wireless controlled as MasterConnect on request. Remote, wireless occupancy & daylight IP65 sensor available to allow significant energy savings and wireless connectivity. Mounting without tools into any type of suspended ceiling. Body is made of aluminium. Standard colour RAL 7016 any other colour on request. Selection of beam angles, lumen outputs and drivers allows to use this luminaire in different types of lighting projects. Standard luminaire is not intended for use in increased corrosivity category environment, e.g. with increased salt concentration. Extra corrosion protection is available on request. Luminous flux & Luminaire Power tolerance up to 10%. System power consumption depends on components used. Luminous efficacy depends on type of LED's, electronics, optics and diffusor. The most up to date technical parameters can be found on our website and in database of LDT files.

Lighting direction



PDF datasheet:



TANKLIGHT 140

Mounting:	Recessed mounting, brackets included
Body material:	Aluminium and steel
Colour:	Standard anthracite grey RAL 7016, other RAL colours on request
Lumen output:	Standard up to 3000 lm any other on request
LED module:	Signify (Philips), Tridonic or equivalent COB LED module
Colour temperature:	3000/4000K/2700-6500K TunableWhite, other on request
Colour Rendering:	CRI>80 in standard, other on request
Driver:	EVG on-off/DALI/MC (MasterConnect)/TW DT8, other on request
Wireless control:	Philips MasterConnect
Daylight/Occupancy sensor:	MC IP65 wireless sensor, other on request
Emergency unit:	N/A
Operating temperature range:	-20°C ... +40°C
IP Class:	IP65 in standard
Power:	220-240V 50/60Hz
Lighting direction:	Direct lighting
Light distribution:	Symmetric
Optics:	Aluminium reflector
Beam angle:	12°/22°/36°/56°
Diffuser:	CG clear glass
Warranty:	5 Years standard warranty

TANKLIGHT 140 recessed mounted luminaire

All current index numbers, lumen outputs, power consumption and many other technical information are available in our 2024 pricelist.

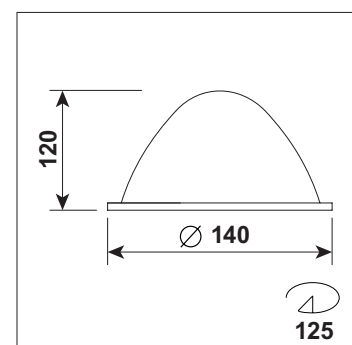

Basic dimensions